

SME

Models 301 Z-R, 301 O-R and 3009-R
Precision Pick-up Arms

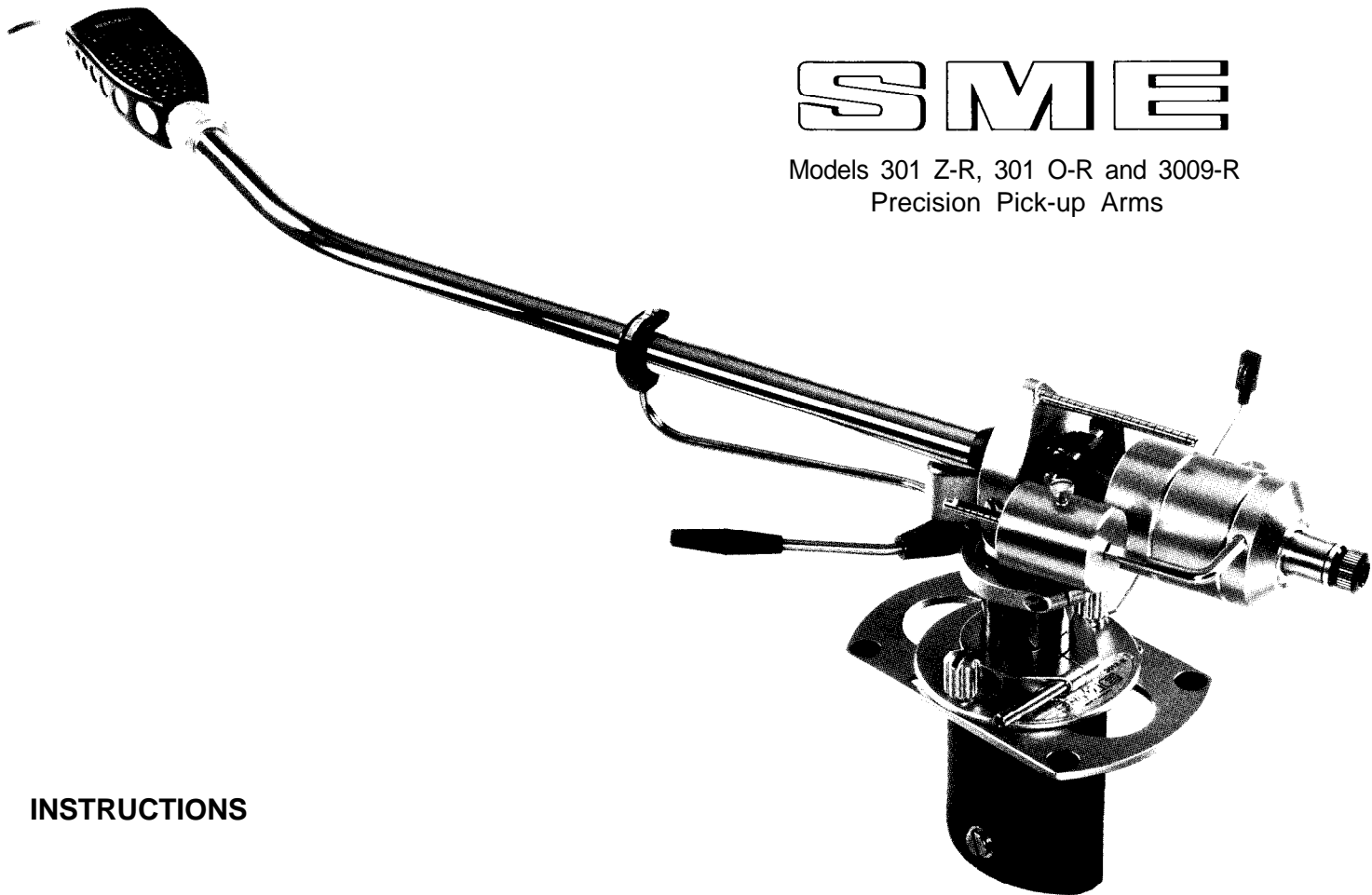

INSTRUCTIONS

Introduction

Manufacture of Series II Precision Pick-up Arms ended in 1972. In response to many requests to reintroduce them for professional and enthusiast hi-fi application we have produced the Models 3012-R, 3010-R and 3009-R. They are basically similar to their classic predecessors but with important refinements including:-

Thin walled stainless steel tone-arm.

New design balance system with longitudinal and lateral fine adjustment for cartridges weighing from

1 X-26 grams or plug-in heads up to 33 1/2 grams.

Extra-rigid low mass shell with double draw-in pins

Geometry optimised for 12" records.

These arms are suitable for all cartridges having standard 1/2" fixing centres and a minimum vertical tracking force requirement of 1.25 grams. Below this the use of one of our Series III arms is recommended.

Please read this instruction book carefully before attempting installation and use.

Following a policy of continuous improvement we reserve the right of any consequential departure from illustration or specification.

Contents

Page	
2	Introduction
4	Dimensions, Model 3012-R
5	Dimensions, Models 301 O-R and 3009-R
6	Contents of the pack
7	Layout
8	Fitting the balance
9	Fitting the arm
10-11	Fitting the cartridge
12	Audio lead
13	Longitudinal balance and tracking force
14	Lateral balance
15	Height adjustment
16	Cartridge azimuth
17	Tracking adjustment
18	Bias adjustment
19	Operation
20-21	Fitting the Fluid Damper
22	Filling the Fluid Damper
23	Cleaning the arm lift
23	Appendix

Dimensions 3012-R

Inches mm

Nominal length, pivot
to stylus

12 1/8 307.34

Distance from bedplate
centre to turntable
centre (L)

11 9/16 294.1

Tracking adjustment

+/-1/2 12.7

Height above mounting
surface (H)-adjustable

max. 3 1/8 79.3
min. 2 3/8 60.3

Height of turntable
surface above mounting
surface (T) max.

1 5/8 41.3

min. 1 1/16 27.0

Depth required below
mounting surface(D)

1 7/8 47.6

Clearance required for
balance weights (R)

3 1/4 82.5

Clearance required
between turntable
surface and cabinet lid (C)

1 3/4 44.5

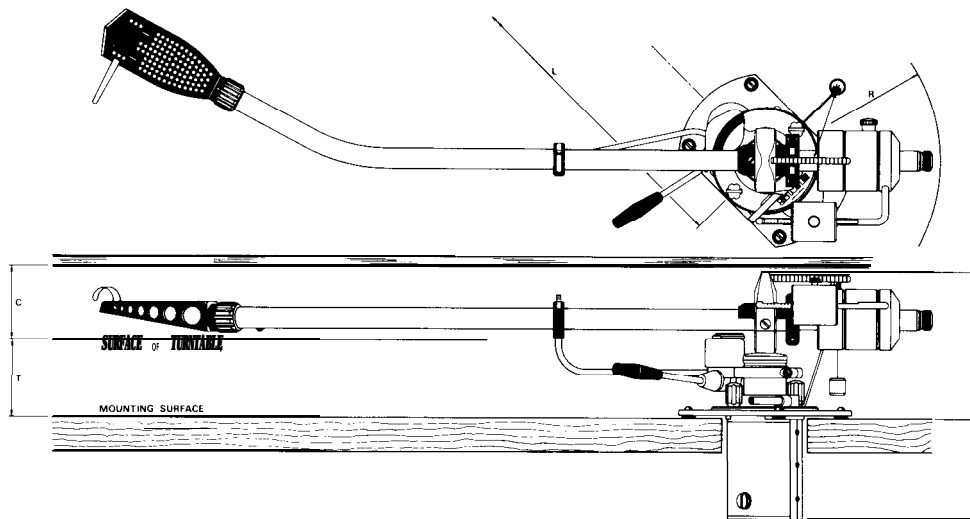

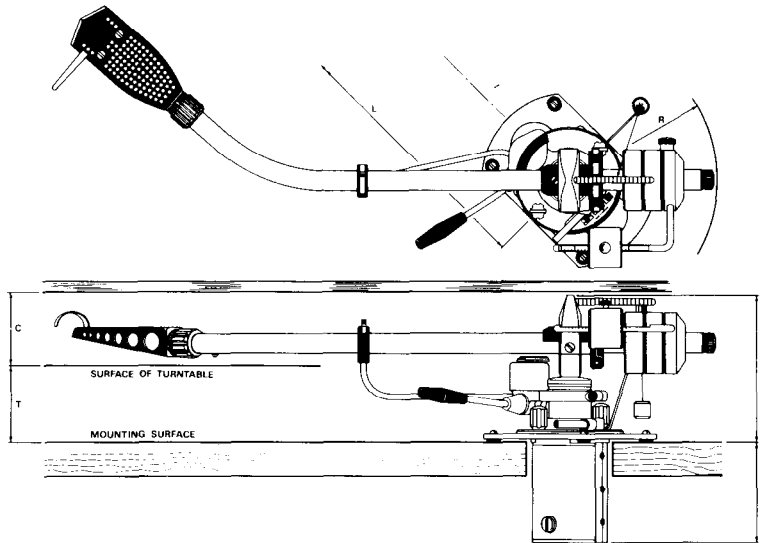

Dimensions 3009-R

Inches mm

Nominal length, pivot to stylus	9 1/8	231.8
Distance from bedplate centre to turntable centre (L)	8 1/2	215.4
Tracking adjustment	± 1/2	± 12.7
Height above mounting surface (HI-adjustable)		
max.	3 1/8	79.3
min.	2 3/8	60.3
Height of turntable surface above mounting surface (T)		
max.	1 5/8	41.3
min.	1 1/16	27.0
Depth required below mounting surface(D)	1 7/8	47.6
Clearance required for balance weights (R)	2 3/4	69.9
Clearance required between turntable surface and cabinet lid (C)	1 3/4	44.5

Dimensions 3010-R

Nominal length, pivot to stylus	9 7/16	293.3
Distance from bedplate centre to turntable centre(L)	8 3/4	222.0

From hereon the Model 3010-R is not mentioned in the instructions as it only differs from the Model 3009-R in these two dimensions

Contents of the pack

The pack is the only one in which your Model 3012-R or 3009-R precision pick-up arm can be safely transported. Please keep it for possible future use. It contains the following:–

- 1 – Model 3012-R or 3009-R precision pick-up arm with balance weights detached
- 1 – Balance and rider weight assembly
- 1 – S2-R shell with finger lift
- 1 – Audio lead
- 1 – Bias weight and filament
- 1 – Bias guide
- 1 – Nylon box spanner
- 1 – Set of cartridge fixing screws (alloy), nuts and spacers
- 1 – Hexagon wrench
- 1 – Set of four woodscrews and steel washers
- 1 – Instruction manual
- 1 – Mounting template
- 1 – Alignment protractor
- 1 – Guarantee registration card

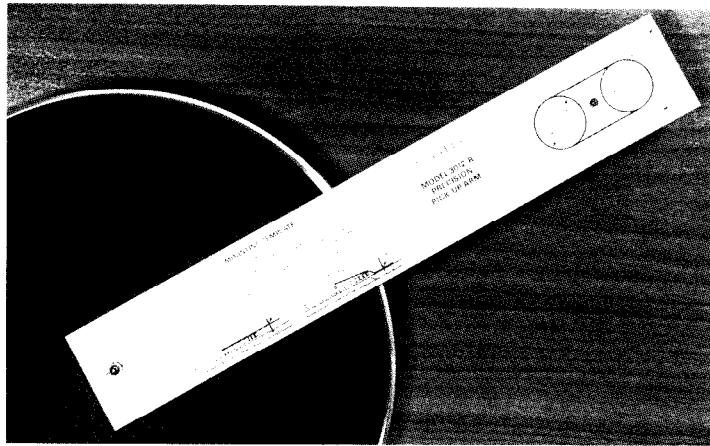

1201

Layout

The Model 3012-R is a 12" (16" U.S.nomenclature) pick-up arm and therefore requires more space for its installation than is usually to be had. Suitable decks are becoming available but when adapting others rigid coupling must exist between the platter and the surface on which the arm is mounted. It would not for instance be satisfactory to mount the arm outboard on a fixed portion of a deck incorporating a floating sub-chassis

1201 Establish the position for the bedplate with the mounting template in accordance with the instructions printed on it.

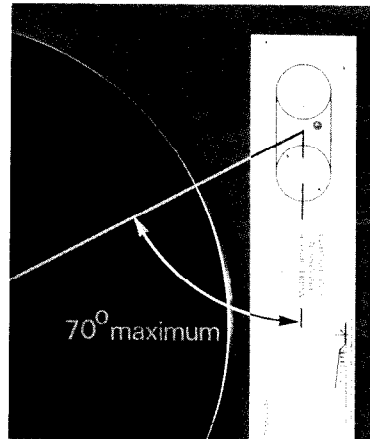

1202

1202 Normally the arm will be installed so that the centre line of the bedplate is radial with the turntable. Sometimes this is not possible, particularly in the case of the Model 3009-R, and the template can then be rotated about the point 'A' into another position. This reduces the effective range of tracking adjustment but is not detrimental so long as the requirements of the alignment protractor can be satisfied. A departure of 70° is probably the maximum that will allow this.

1203 Drill and form a cut-out in accordance with the template. Ensure that it is large enough to clear the screening can completely. Drill the four pilot holes for the woodscrews

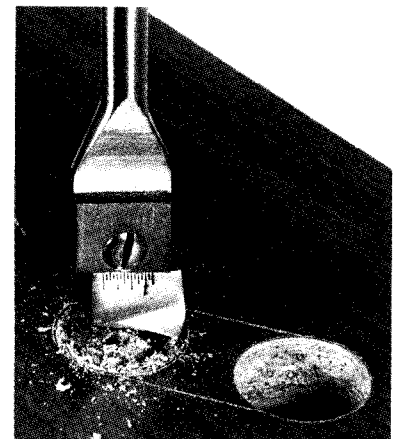

1203

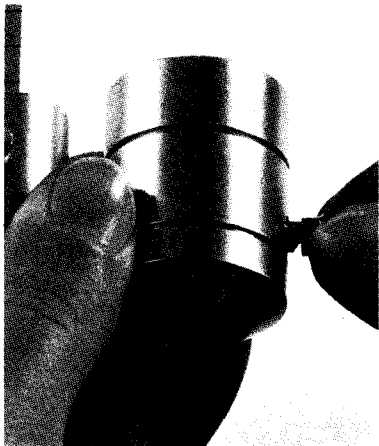

1204

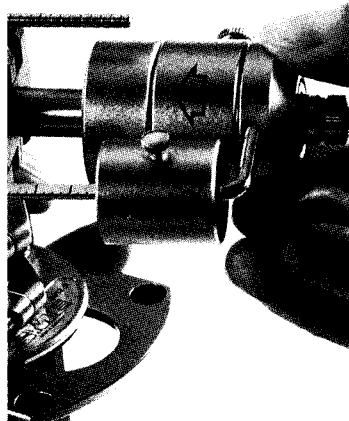

1205



1206

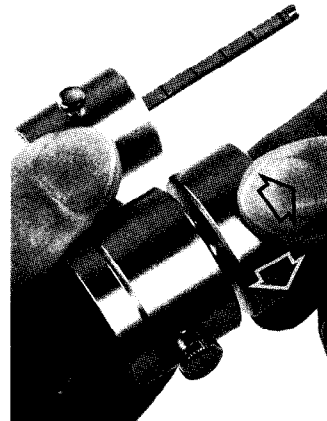

1207

Fitting the balance weight

As supplied the balance and rider weight assembly is packed separately and it is convenient to fit them at this stage

1204 The leadscrew follower control on the side of the main balance weight moves outwards as it is rotated and should be in this position for fitting

1205 Slide the balance and rider weight assembly on to the tone-arm extension.

1206 Support the rider weight so that the way-rod is horizontal when viewed from the rear. Rotate the leadscrew follower control into the position that will allow it to move inwards through the slot in the tone-arm extension. Slight rotation of the main balance weight one way or the other will assist the leadscrew follower to enter the slot and pass into engagement with the leadscrew.

1207 The complete main balance and rider weight assembly caters for cartridges in the range 13-26 grams. It is in two parts and the front may be detached by rotating and withdrawing it from the main weight. When this has been done the range covered is 1½-14 grams.

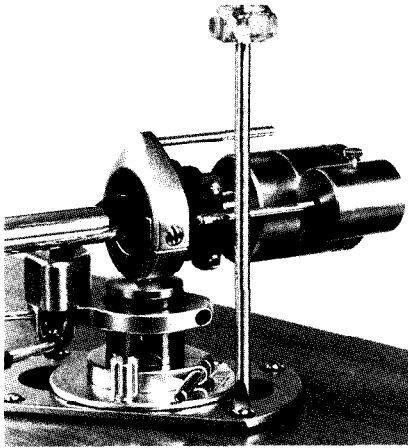

1208

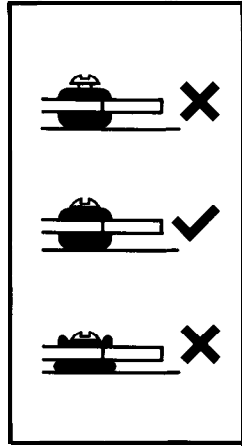

1209

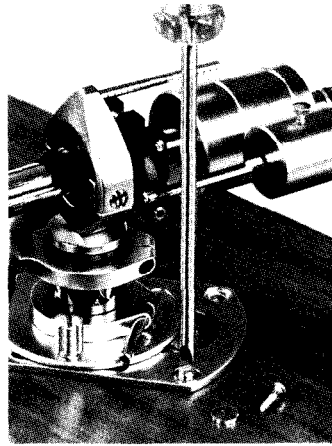

1210

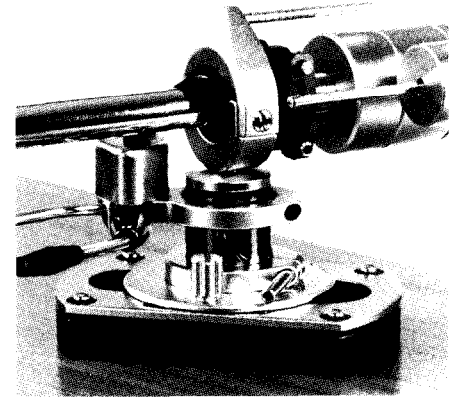

1211

Fitting the arm

1208 Insert the four woodscrews through the grommets in the bedplate and screw partly home. As delivered the arm height is adjusted to suit its pack. It may therefore be necessary at this point to re-adjust it to clear the turntable by reference to page 15 paragraphs 1233-1 235.

1209 Tighten the woodscrews as shown.

1210 As an alternative, hard mounting may be preferred. It is then necessary to remove the rubber grommets from the bedplate and to place one of the steel washers under the head of each woodscrew before inserting and fully tightening them.

1211 When the surface of the turntable is more than 1 5/8" (41.3 mm) above that on which the bedplate is mounted, a spacer SME accessory is required. It is complete with woodscrews. Nuts and bolts are also available on request for fixing to metal decks.

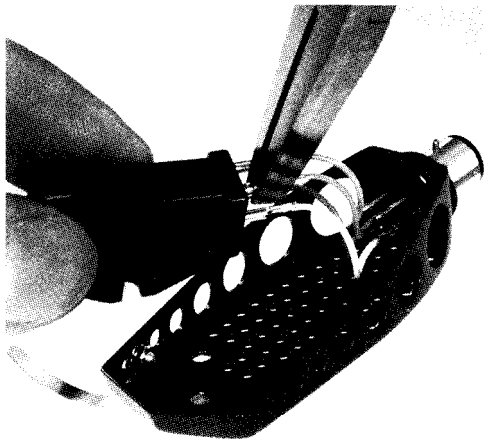

1213

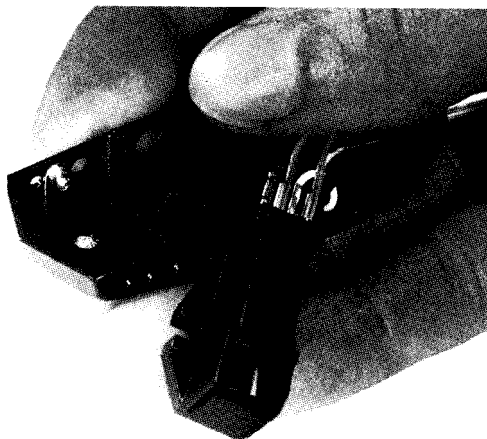

1214

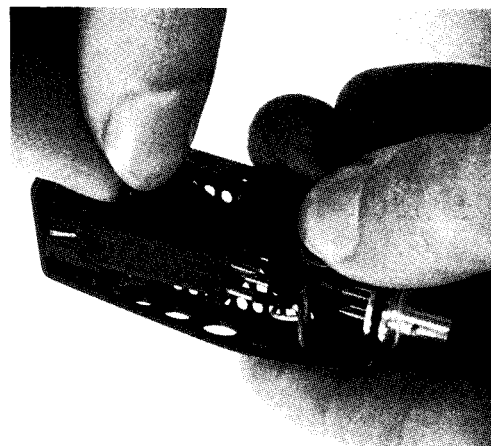

1215

Fitting the Cartridge

1213 Fit the pin jacks to the cartridge terminals using a small pair of fine nosed pliers. If you don't have a Pair. buy them ~ they will be a good investment for work on your system generally and otherwise you will almost certainly damage the pin jacks. Connectrons are:-White to left channel Red to right channel: Blue to left ground, Green to right ground. To accommodate variations in terminal diameter the jacks may have to be closed down with the pliers or opened up with a screwdriver blade as required.

Connectrons must never be made by soldering the wires directly to the cartridge terminals

1214 Select screws of appropriate length. Do not use spacers between the cartridge and shell unless the cartridge contours make it unavoidable.

1215 Fit the nuts. Sometimes it is convenient to place spacers between the cartridge and the nut or even to invert the screws, placing the nuts on top of the shell

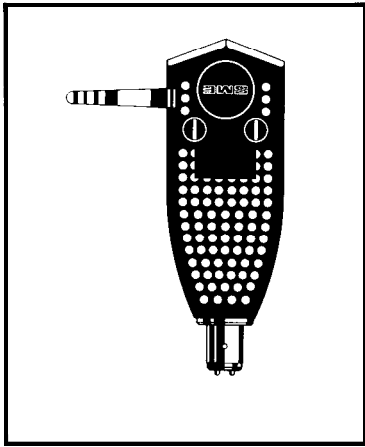

1216

Fitting the cartridge (Cont'd)

1216 It is important to check that the cartridge lies symmetrically in the shell.

1217 Align the screw slots for a neat appearance.

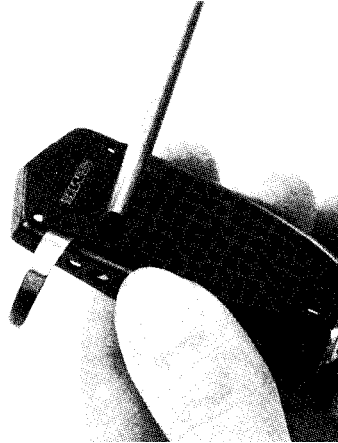

1217

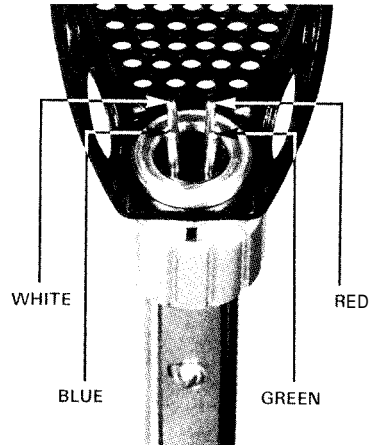

1219

1219 Replacement wires are available for the shell and should be fitted with due regard to the colours indicated. The fitting procedure is the same as already described in paragraph 1213.

1220 Insert the S2-R shell in the arm socket and press Inwards until the draw-in pins contact the thread of the socket nut. Maintaining pressure, rotate the socket nut to draw the shell home. It should be tightened firmly but not to the point of strain.

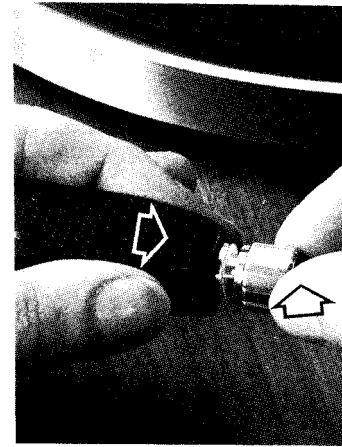

1220

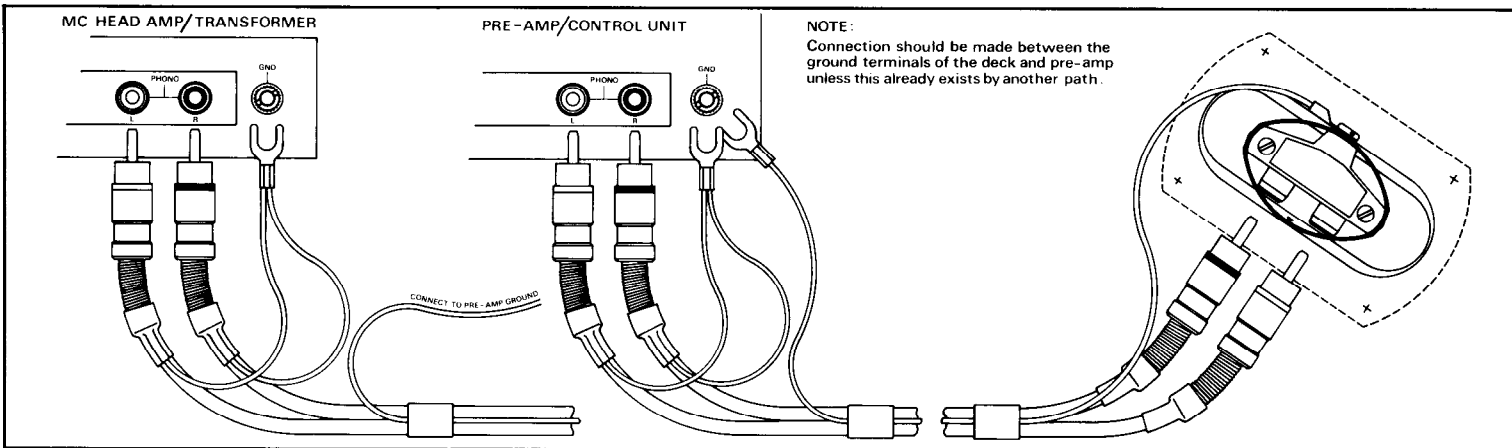

1221

LCOFC Audio Lead

1221 The illustration shows use with and without a mc head amp/ transformer and phono plug connections should be made accordingly.

Connect the ground lead serving the arm to the pre-amp ground, and those from the rear of the phono plugs to the ground terminal on the piece of equipment to which these plugs are connected.

If the turntable has a ground terminal, it too should be connected to the pre-amp ground, provided it is not already grounded by another path.

The system has been designed for a high SIN ratio and if this is not achieved multiple ground paths or the over proximity of mains equipment will be likely causes. Some cartridges have an external foil tag connecting the right channel ground terminal to the cartridge body. For use in a metal shell it will be necessary to remove this with a small pair of tweezers or the point of a blade, lifting the tag off over the terminal pin. If this is not done a ground loop may be formed, causing hum on the right channel

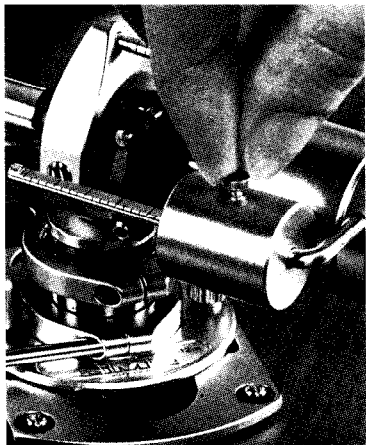

1225

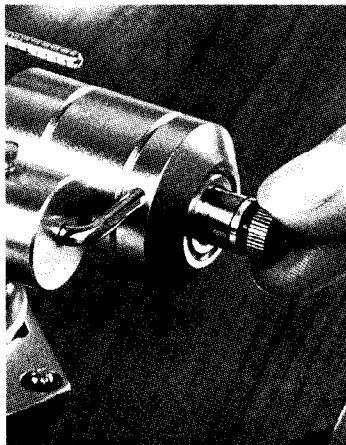

1226

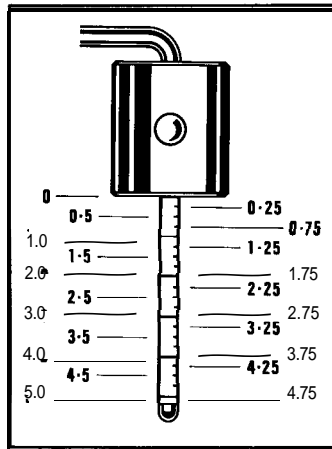

1227

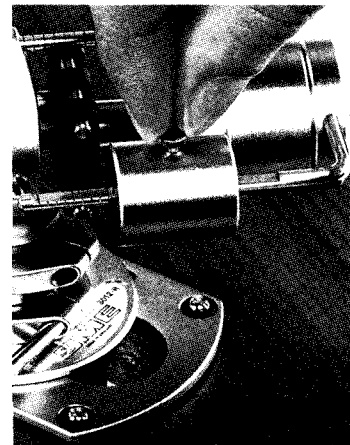

1228

Longitudinal balance and tracking force

1225 Release the locking screw of the rider weight and move it backwards along the way-rod as far as it will go. Re-lock the screw.

1226 Longitudinal balance is achieved by moving the main balance weight along the tone-arm extension. If desired, large movements can be made by disengaging the leadscrew follower and engaging it again at a point of approximate balance (paragraphs 1204-1206). Fine adjustment is then effected by rotating the knob at the end of the tone-arm extension until the arm with cartridge fitted assumes a level position or somewhere between this and bare contact with the record.

1227 The way-rod is calibrated for 5 grams vertical tracking force. Quarter grams are indicated by the short lines on the edge of the way-rod and gram units by the long lines which pass right across it.

1228 Unlock the rider weight locking screw, set the desired vertical tracking force and re-lock.

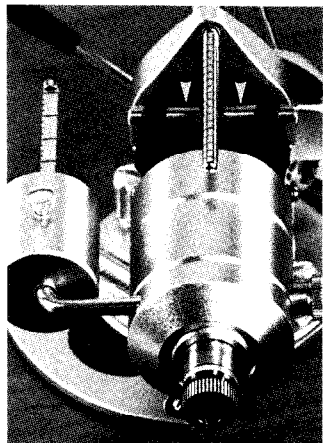

1229

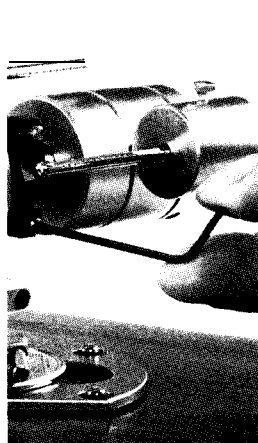

1230

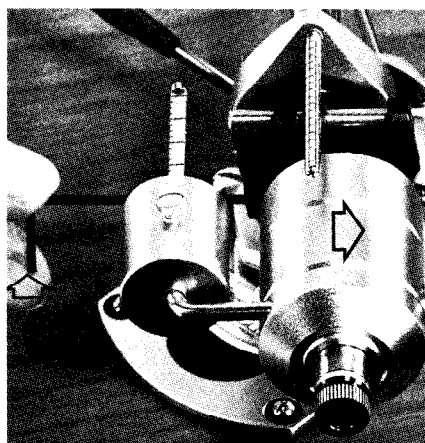

1231

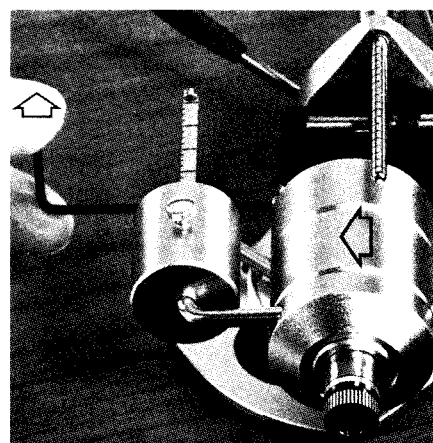

1232

Lateral Balance

The tone-arm extension with balance and rider weight assembly can be moved transversely to achieve lateral balance.

1229 On leaving the factory it is set centrally.

1230 Re-adjustment is made using the long arm of the hexagon wrench inserted into the socket of the lateral balance leadscrew.

When balanced on a level deck with no tracking force applied the arm should remain stationary at any point over the recorded portion of the disc

1231 If the shell swings towards the record spindle the hexagon wrench should be rotated clockwise.

1232 If the shell swings away from the record spindle the hexagon wrench should be rotated anti-clockwise.

When an approximate setting has been achieved make adjustments a little at a time removing the hexagon wrench between each.

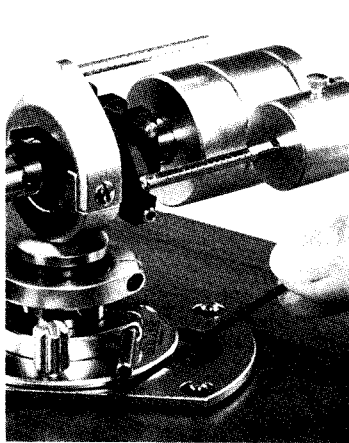

1233

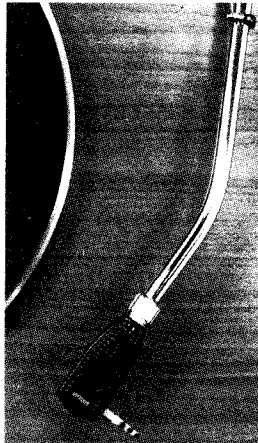

1234



1235

Height adjustment

- 1233 Support the lowering and raising control with one hand and release the pillar clamp with the other.
- 1234 Rotate the pillar to position the arm rest conveniently in relation to the turntable. The shell should not be more than 3" (76 mm) or less than 1" (25 mm) from its edge. At the same time raise or lower the pillar in the base so that the arm will be approximately parallel to the surface of the record when it is being played. Re-lock the pillar. view the arm in the playing position and re-adjust as necessary

- 1235 The horizontal datum of the cartridge is usually the top of it. If it has been correctly fitted it will be parallel with the top of the shell and consequently with the tone-arm.

The raising and lowering control is adjusted at the factory to raise the stylus approximately 25" (6 mm) above the surface of the record and this should be achieved if the arm has been correctly installed and adjusted



1236

Cartridge azimuth

1236 Place a small mirror on the turntable and rest the stylus on it. Viewed in this way any departure from vertical is accentuated and easily visible.

1237 To adjust it is necessary to release the locking screw underneath the tone-arm.

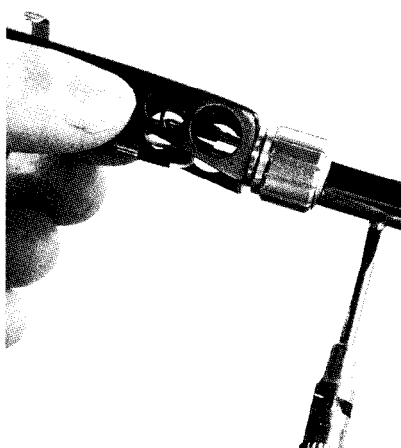

1237

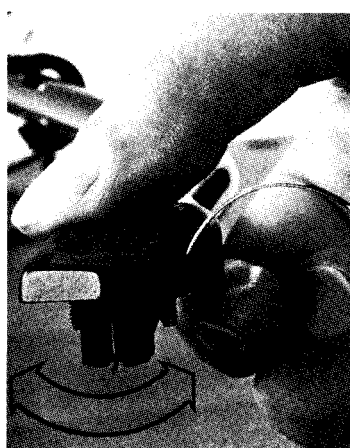

1238



1239

1236 Hold the shell firmly close to the tone-arm with one hand and twist it in the required direction holding the tone-arm firmly with the other. The stylus must be clear of the mirror whilst this is done. Movement of the socket in the end of the tone-arm is limited by the locking screw.

1239 Re-check with the mirror and when satisfied lightly re-lock the screw underneath the tone-arm.

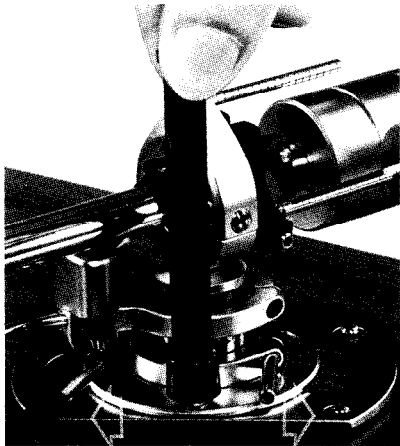

1240

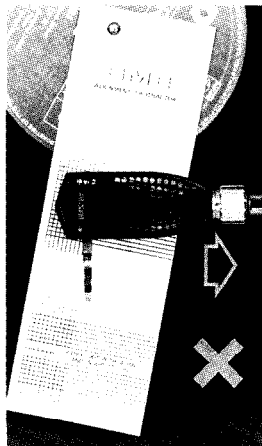

1241

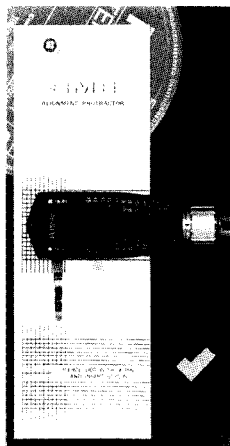

1242



1243

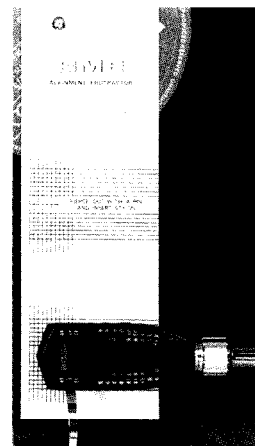

1244

Tracking adjustment

1240 Release the two base clamp nuts on either side of the arm with the nylon box spanner.

1241 Having pierced the alignment protractor for the stylus, place it on the turntable spindle. Move the base on the bedplate as far forward as it will go.

1242 The protractor provides two null points, the inner at 2.60" (66 mm) radius and the outer at 4.76" (121 mm) radius. Move the base on the bedplate until the cartridge and shell appear symmetrical with the lines on the protractor at the inner point.

1243 Inaccuracy is shown and the arrow indicates the direction of movement necessary to correct it.

1244 Similarly check the outer point and adjust the arm until the conditions shown in 1242 and 1244 are both met. Firmly re-lock the outer base clamp nut only.

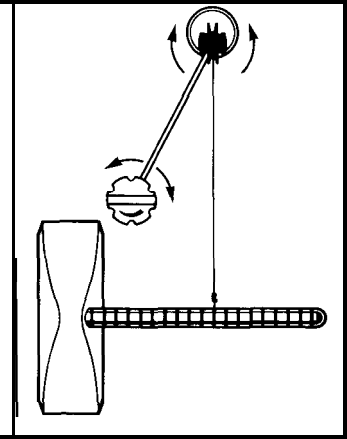
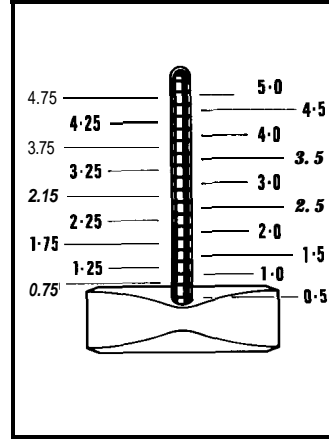
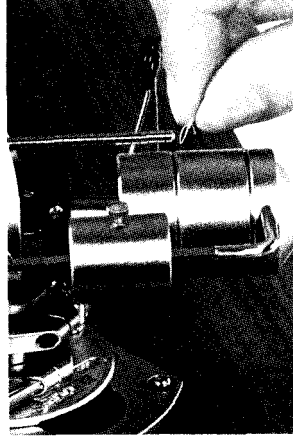
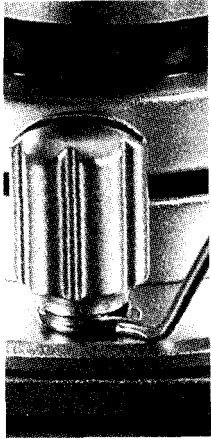

1245

1246

1247

248

1249

Bias adjustment

- 1245 Remove the inner base clamp nut and pass the bias guide over the base clamp bolt. Replace the base clamp nut and tighten, lightly
- 1246 Thread the filament through the bias guide pulley housing
- 1247 Pass the loop over the bias lever.

- 1248 Drop the loop into the groove corresponding to the vertical tracking force being used Gram units are indicated by the red grooves on the bias lever
- 1249 Position the bias guide so that the filament is at approximately 90° to the bias lever when the stylus is over the outer groove of a 12" record. Firmly re-lock the base clamp nut to secure it. Rotate the guide pulley housing to align it with the filament which must lie the groove of the pulley.

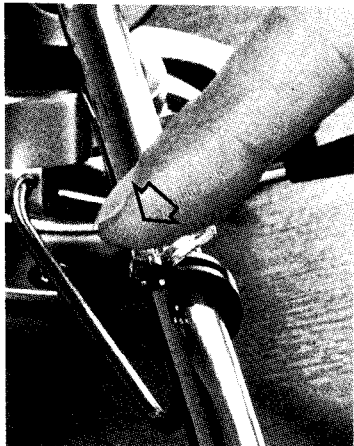

1250

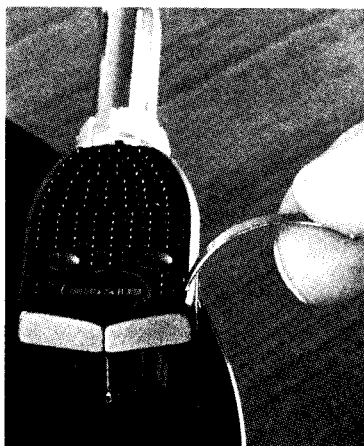

1251

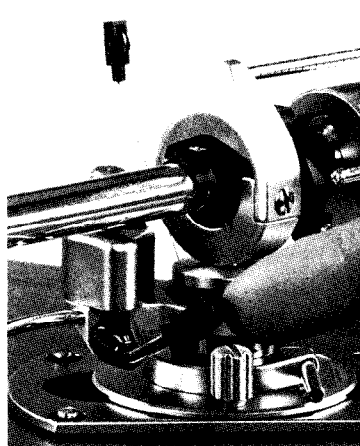

1252

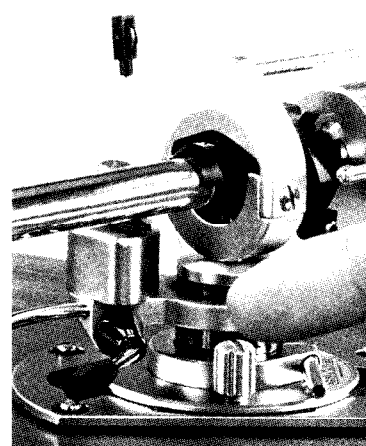

1253

Operation

1250 With the control lever raised release the tone-arm from its rest.

1251 Place the stylus over the selected band on the record

1252 Move the control lever forwards

1253 Allow it to fall freely.

After playing, raise the control lever to lift the stylus from the record and then return the arm to its rest.

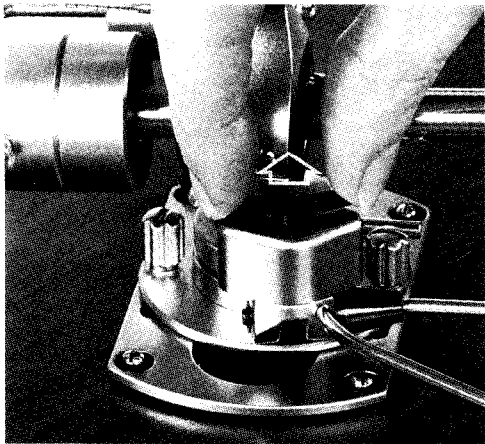

1254

Fitting the Damper FD. II-R

This is an accessory for either arm. It is optional, but the handling of a damped arm is often preferred. One effect is to reduce sensitivity to external shock or vibration. For example, it has proved an effective remedy to groove jumping caused by people walking in proximity to the deck on a suspended wooden floor.

The damper should be fitted before the balancing operation 1225 on page 13.

1254 Raise the control lever and holding the arm-lift between the finger and thumb pull it upwards out of the control.

1255 Fit the tank over the dashpot jacket, seating it down on to the face of the control bracket.

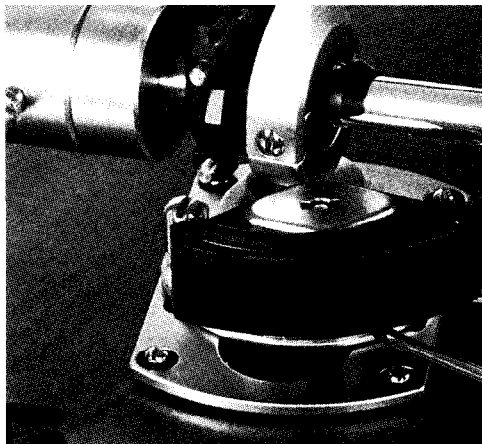

1255

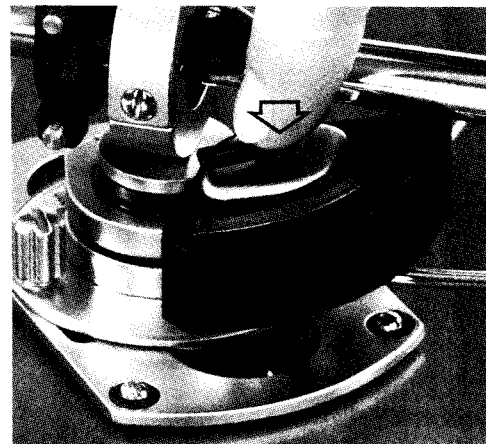

1256

1256 Re-fit the arm-lift pressing it down with a firm finger pressure.

Paddles of three widths are provided. We recommend their use as follows:

Black paddle for tracking forces up to 1.5 grams.

Grey paddle for tracking forces 1.5-1.75 grams.

White paddle for tracking forces 1.75 upwards.

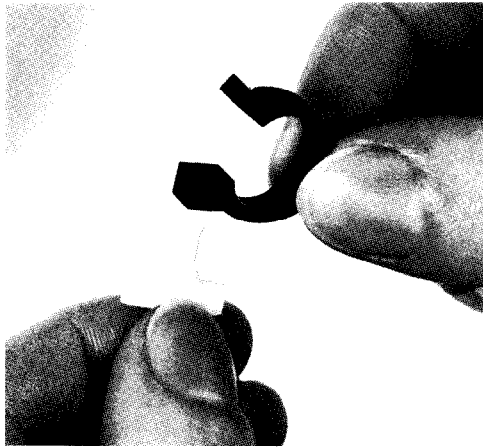

1257

Fitting the Damper (Cont'd)

- 1257 Hold the selected paddle with its convex surface towards you. Insert the squared end of its shank into the lower jaw of the paddle clamp. It has a slight taper and should remain in position if pushed lightly home.
- 1258 Ensure that the tone-arm and paddle clamp are free from dust or foreign matter which might mar the polished finish of the tone-arm. Place the paddle clamp on the tone-arm and lightly tighten the knurled paddle retaining screw.

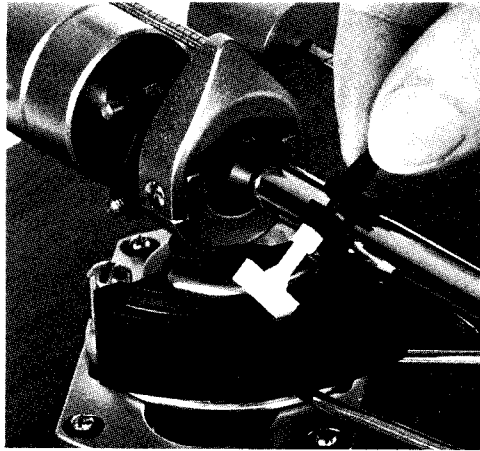

1258

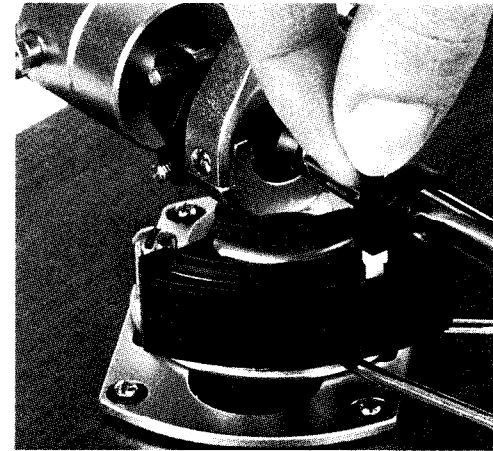

1259

- 1259 Position the clamp on the arm so that the paddle is in the centre of the slot in the tank and rotate it until the shank is vertical when viewed from the front. Lock by tightening the knurled paddle retaining screw. Check that there is no interference between the paddle and the tank by moving the arm through its normal operating arc and at a height corresponding to playing conditions. Check the arm for balance and tracking force as directed on page 13.

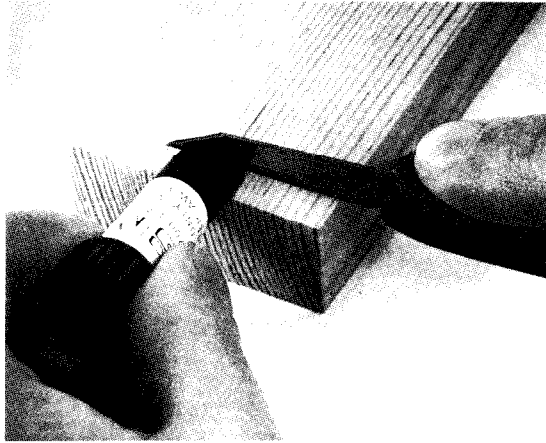

1260

Filling the Damper

1260 The flask contains 2 mls of damping fluid and is a metered amount for one filling of the tank. Slice off the end of the flask with a sharp trimming knife at the point indicated.

1261 Engage the flask in the top of the tank so that it stands upright.

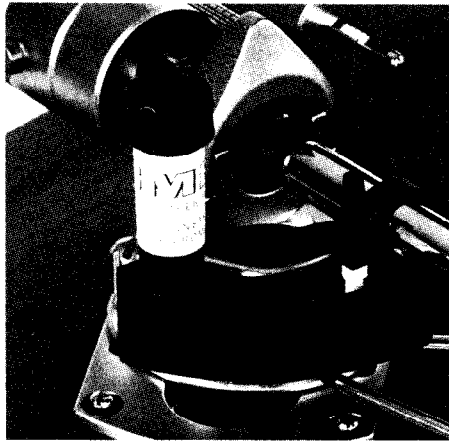

1261



1262

1262 Unscrew the cap from the flask allowing the fluid to flow into the tank and settle. Leave in place until the flask is completely empty. Carefully remove the flask.

We recommend an annual fluid change. Use only genuine Part No. FD 2013, obtainable from your dealer or direct from ourselves.

WARNING

Silicone fluid can cause discomfort if introduced into the eyes. It is therefore advisable to wash your hands at this point.

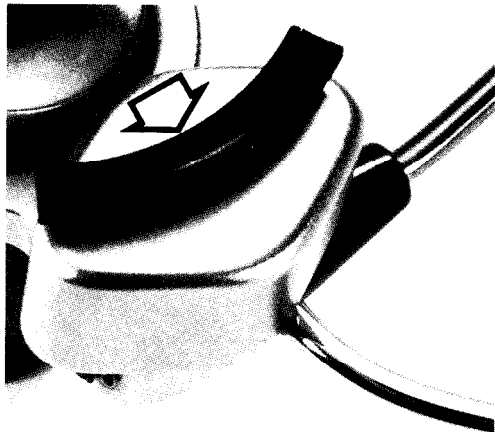

APPENDIX

We hope these instructions have made installation of your Model 3012-R or 3009-R precision pick-up arm simple and straightforward. Care for it as you would a camera. Do not attempt to take it to pieces. Do not apply oil or other lubricants to any part of it.

If you have a problem concerning the operation or repair of your pick-up arm, write to the address overleaf. We provide quick and efficient service direct from the factory to any part of the world. In the first instance please quote the model, type and serial number. Do *not* send the arm to us unless requested to do so.

1263

Cleaning the Armlift

1263 If the arm drifts outwards during lowering and raising it usually indicates the presence of contaminant on the rubber insert in the arm lift. To restore positive working proceed as follows:-

- (a) Wipe the insert with a damp cloth.
- (b) Repeat with a paper tissue until it is quite dry.
- (c) Clean the underside of the tone-arm where it contacts the rubber in the same way.

SME

The best pick-up arm in the world

MANUFACTURED BY . SME LIMITED . STEYNING . SUSSEX . BN44 3GY . ENGLAND

☎ (01903) 814321 · ☒ (01903) 814269